

- Multi Channel Power Control
- Power Distribution management
- Suitable to communicate with PLC & Multiloop
- High precision measurement
- Elimination of power overshoot
- Power factor maintained close to 1
- Most popular Field Bus available
- Easy to use
- CE EMC listed

**CD AUTOMATION**

**POWERED BY INNOVATION**

# REVO PC

POWER CONTROLLER



## Multi-Channel SCR Power Controller

Suitable to control Electric Heaters  
and High Power Industrial Heating Systems



[www.cdautomation.com](http://www.cdautomation.com)  
Revo PC Catalog 2022

# HAVE YOU CONSIDERED HOW POWER PEAKS COULD BE A PROBLEM TO YOUR BUSINESS?

The REVO PC unit is designed to handle applications with multiple zones. This enhanced unit, thanks to a particular algorithm, minimizes your energy costs through the synchronization and the power limit for each zone. Revo PC keeps your instantaneous power within the limits of your electricity supply contract.



## REVO PC POWER CONTROLLER

Created specifically for industrial multi-zone applications, REVO PC can be configured to control up to 24 channels/zones. Each zone can be sized from 30A up to 800A (REVO S Family with SSR input and Random Firing).

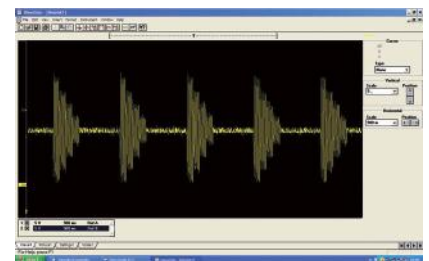

CURRENT WAVEFORM WITHOUT POWER CONTROL OPTIMISATION

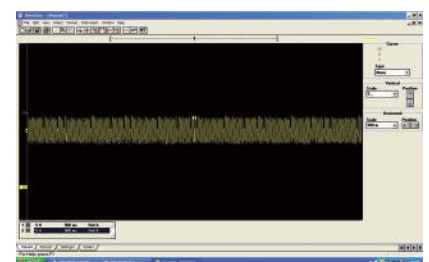

CURRENT WAVEFORM WITH POWER CONTROL OPTIMISATION

## IMPORTANT POWER CONTROL FUNCTIONALITY IS OFFERED BY REVO PC INCLUDING:

- Power distribution management
- Elimination of power overshoot.
- Power factor maintained close to 1.
- Energy monitoring true RMS measurement
- Stay connected with the most popular Field Bus protocols.
- Eliminate use of PLC output modules by using comms for Power to CPU connections.
- Alarm notification per zone of heater break and thyristor short circuit.
- REVO PC's considered design not only helps you save start-up costs but ensures you keep on saving money throughout the products lifetime.



# POWER OPTIMIZATION

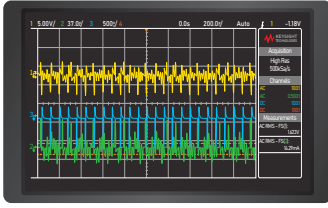

Without REVO PC

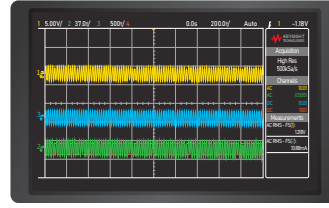
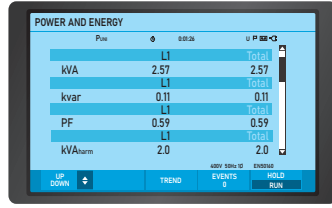

With REVO PC

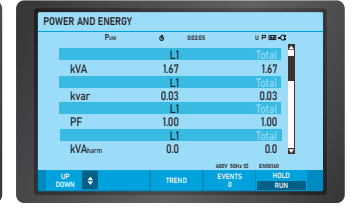

In multi-zone applications, the non-synchronized insertion of the different loads can create a simultaneity of insertions generating peak current that produces disturbances on the power line. REVO PC distributes the power demand of the individual zones keeping the line current as constant as possible.

# NETWORK DISTURBANCE



Without REVO PC

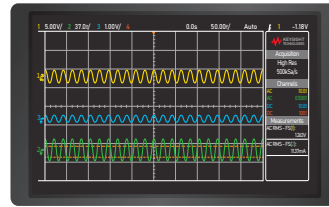
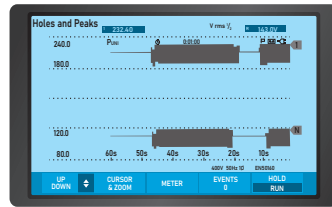

With REVO PC

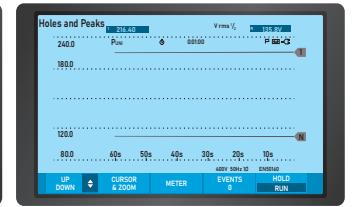

The insertion of loads that are not synchronized on the power line can cause disturbances, such as fluctuations in the mains voltage (Flickering), network holes and losses on the power cables.

# HARMONIC COMPONENT



Without REVO PC

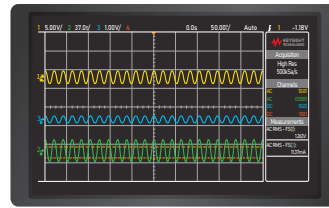
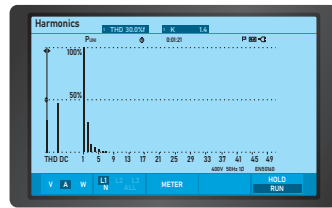

With REVO PC

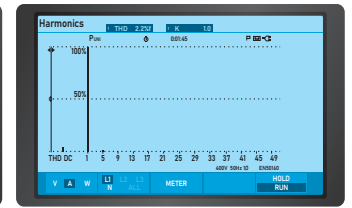

The management and insertion of unsynchronized loads can lead to an increase in the harmonic component generated (THD). This effect increases losses, generates noise and can generate overheating of the power cables.

# OPTIMIZATION OF ENERGY COST

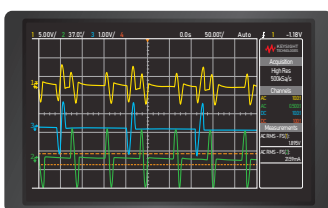

Without REVO PC

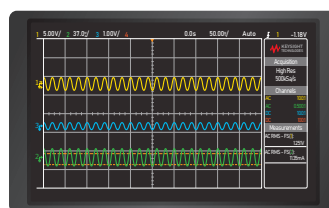
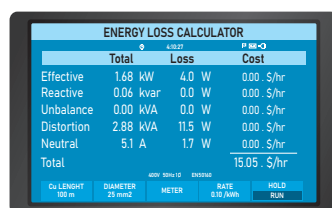

With REVO PC

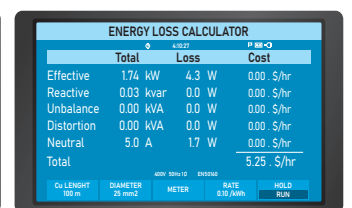

Thanks to its control strategy and the distribution of the power required in the management of multizone loads, REVO PC keeps the Power Factor values close to 1.

# CONNECTIVITY AND CONFIGURATION

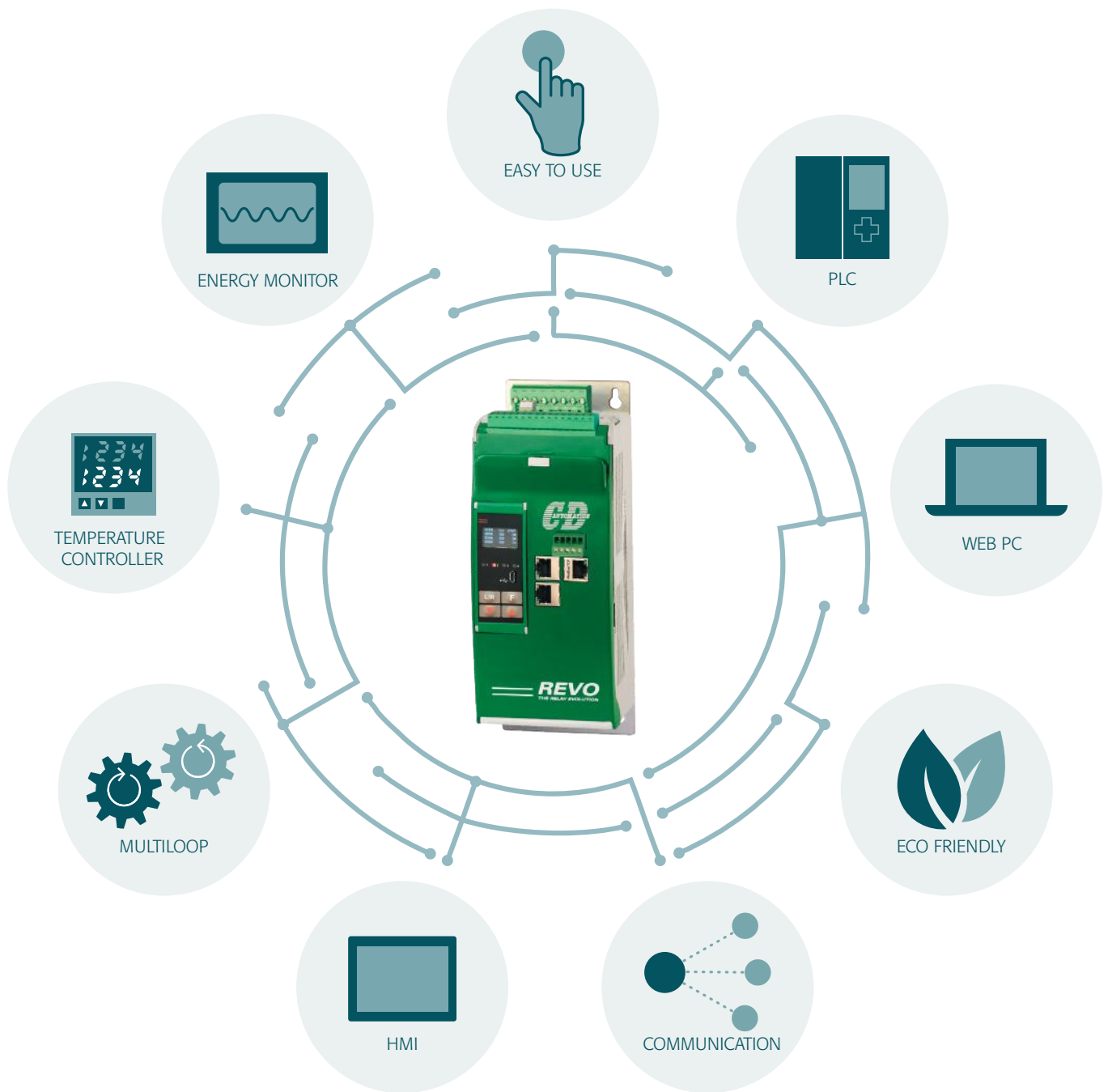

READ for each zone	WRITE for each zone
Set Point	Set Point
Alarm	Load configuration
Voltage	
Power	
Current	
Heater Break Alarm	
SCR Short Circuit Alarm	

# EFFICIENT ENGINEERING

A key benefit is the incorporation of REVO PC into the Siemens TIA Portal. By using PROFINET I/O field bus or Modbus RTU and TCP communication with Siemens S1500 PLC, all REVO PC units will fall back on a shared database, a standardized operating concept and centralized services. You will get benefit from faster commissioning and reduced engineering overhead.

On our website [www.cdautomation.com](http://www.cdautomation.com) you can download libraries developed in the SIMATIC TIA Portal environment.

These libraries, integrated in the automation projects developed in the SIMATIC TIA Portal environment, will make the integration and dialogue of our products with the SIEMENS PLCs of the S7 1500 series simple and immediate for our customers.

The libraries will be compatible with REVO PC/PN products that will make use of Modbus TCP, Modbus RTU and PROFINET I/O communication.

# CONFIGURATOR SOFTWARE

CDA Thyristor configurator software is free and available to download from our site [www.cdautomation.com](http://www.cdautomation.com).

If the Order Code is in line with requirement, then REVO PC has been already configured in Factory and it's ready to use. You need the software only to modify the ordered configuration. Anyway we suggest to check the unit on the machine with the "Test unit" section.

To install the software, launch the program and follow the instructions on the screen. Run the software configurator and set the serial port of the PC with baudrate.

## TEST VIEW

This page can be used to monitor and adjust the operation of the REVO PC while communicating with it in real time.

Main features available are:

- Set the total number of zones
- Select the source for Power Set Point
- Configure and Monitor the Digital Inputs
- Detect if an alarm is activated
- Set the power of each load
- Set minimum current threshold for each channel
- Main process variable display
- Source power set point display
- Total power limit setting
- Voltage and current calibration

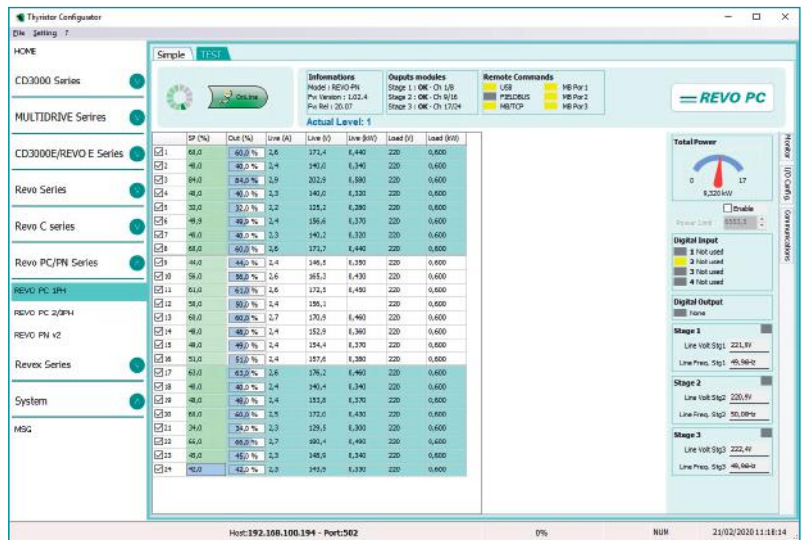

## MODBUS MASTER

REVO PC can have Modbus master port as an option. With this feature it's possible to acquire external set point from different temperature controller with Modbus slave port.

Each temperature control set can be associated to one or more channel.

In the example picture on the left the channel 5 is associated with the temperature controller with address 1. The parameter 3 is dedicated in this controller for the set point.

Instead of using the main output of the controller to set the power, we use the value of power set point available for the communication.

ID	Par Num	Err sts
1	1	3
2	1	3
3	1	3
4	1	3
5	1	3
6	1	3
7	1	3
8	2	3
9	2	3

## CONFIGURATION CABLE

To connect the Revo PC to computer is necessary use a standard micro USB cable (our code CCX).

The windows driver for USB connection is installed by thyristor configurator software installer.

To personal computer  
USB port

USB PORT





# REVO PC POWER CONTROLLER

REVO PC system is based on an intelligent unit that manages one or more basic SCR power controller. All currents are measured with an external current transformer. REVO PC acquires the power setpoint from different sources including: single or multi zone temperature controller, PLC or HMI.



## Control Unit

REVO PC up to 24 channels

- SSR outputs to control up to n° 24 REVO S 1PH
- High precision voltage transducer RS485 and Modbus TCP available as standard
- This Unit transform a simple SCR Power Switch into an Intelligent Unit able to communicate and to have HB Alarm

## Power Unit

REVO S 1PH

- SCR power switches from 30 to 800A
- Internal Fuse
- Max Voltage 480-600-690V
- Up to 24 REVO S connectable
- High precision current transducer

# REVO PC FEATURES

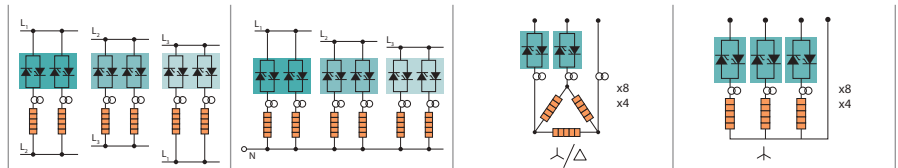

CODE	RPC612	RPC624	RPC412	RPC424	RPC204	RPC208	RPC304	RPC308	
CONNECTION/CONTROL	Phase-Phase shared on three phases		Phase-Neutral		Two Legs		Three legs		
CHANNELS	12	24	12	24	4	8	4	8	
N° of Control Legs for each Channel	1PH	1PH	1PH	1PH	2PH	2PH	3PH	3PH	
<b>General Features</b>	Cover and socket material	Polymeric V2							
	IP code	20							
	Aux Voltage	24Vdc							
<b>Input Features</b>	Number of sensor used	12	24	12	24	12	24	12	24
	Configurable Digital Input calibration	max. 50mA							
<b>Output Features</b>	25A for each channel, Fuse I <sup>2</sup> T 1260 A <sup>2</sup> S								
<b>Firing</b>	Half Cycle at 50% power demand	Standard			Not Available		Standard		
	Single Cycle at 50% power demand	Standard			Standard				
<b>Control</b>	Open Loop	Standard							
	Power Feedback	Standard							
<b>Features</b>	Heater Break + Thyristor short circuit	Standard							
	Current Measurement on communication	Standard							
	Voltage measurement	Standard							
	Power measurement	Standard							
	Three Phase balancement	Standard							
<b>Communication</b>	N°1 Modbus TCP and N°3 Modbus RTU Slave	Standard							
	Profibus DP and Modbus TCP	Option							
	Profinet and Modbus TCP	Option							
	Ethernet IP and Modbus TCP	Option							
<b>Digital Input</b>	N° of Digital Input	4							
	Enable Disable Function	Standard							
<b>Relay Output</b>	Relay Output	Option							
<b>Option</b>	REVO KP PC	Option							
<b>Temperature Control</b>	Can be added externally	Option							
<b>Approval</b>	CE EMC	Standard							

# RPC612 / RPC624 - up to 24 1PH channel shared on the three phases

## Connection Phase to Phase

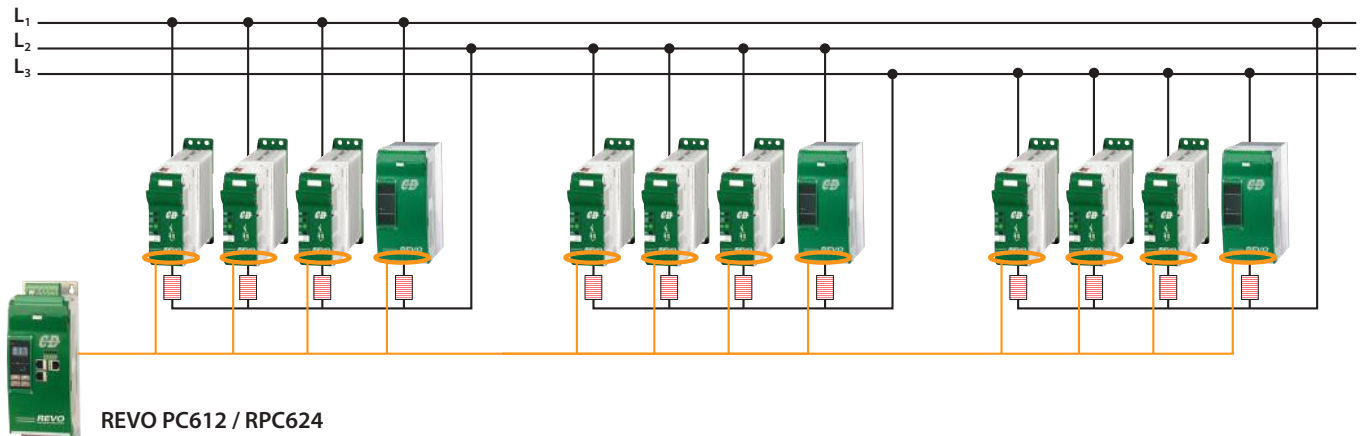

### Example:

N° 1	RPC612-0001411122		REVO PC 612
N° 3	RS1040-40SZOY0021	} L <sub>1</sub> -L <sub>2</sub>	REVO S 1PH 40A, max main voltage 480V, No AUX voltage required, Logic input SSR, Fuse & Fuse Holder + integratedCT
N° 1	RS1090-40SZOY2021		REVO S 1PH 90A, max main voltage 480V, No AUX voltage without Logic input SSR, Integrated Fuses & CT, Fan 230V std
N° 3	RS1040-40SZOY0021	} L <sub>2</sub> -L <sub>3</sub>	REVO S 1PH 40A, max main voltage 480V, No AUX voltage required, Logic input SSR, Fuse & Fuse Holder + integratedCT
N° 1	RS1090-40SZOY2021		REVO S 1PH 90A, max main voltage 480V, No AUX voltage without Logic input SSR, Integrated Fuses & CT, Fan 230V std
N° 3	RS1040-40SZOY0021	} L <sub>3</sub> -L <sub>1</sub>	REVO S 1PH 40A, max main voltage 480V, No AUX voltage required, Logic input SSR, Fuse & Fuse Holder + integratedCT
N° 1	RS1090-40SZOY2021		REVO S 1PH 90A, max main voltage 480V, No AUX voltage without Logic input SSR, Integrated Fuses & CT, Fan 230V std

	1	2	3	4	5	6	7	8	9	10	11	12	13	14	15	16		
<b>ORDER CODE</b>	R	P	C	-	-	-	-	-	-	-	-	-	-	-	-	-		
<b>CONNECTION</b>				<b>4</b>									<b>12</b>					
<b>description</b>				<b>code</b>	<b>note</b>		<b>Firing</b>						<b>code</b>	<b>note</b>				
F1-F2; F2-F3; F1-F3 All the 1PH channel can be balanced on the three phases - Phase to Phase				6			Half Cycle at 50% power demand						1					
							One Cycle at 50% power demand						2					
<b>CHANNELS</b>				<b>5</b>	<b>6</b>									<b>13</b>				
<b>description</b>				<b>code</b>	<b>note</b>		<b>FEED BACK (Control Mode)</b>						<b>code</b>	<b>note</b>				
12 channel REVO PC to drive 12 REVOS-1PH Max with Random Firing				1	2		No Feed Back						1					
24 channel REVO PC to drive 24 REVOS-1PH Max with Random Firing				2	4		Power						2					
<b>One Current Sensor Input for each channel</b>				<b>7</b>	<b>8</b>	<b>9</b>									<b>14</b>			
<b>description</b>				<b>code</b>	<b>note</b>		<b>Approvals</b>						<b>code</b>	<b>note</b>				
Current Sensor is included and integrated with REVO S 1PH units with "Y" Option				0	0		CE EMC						1					
							CE + cUL (pending)						L					
<b>Communication</b>				<b>10</b>												<b>15</b>		
<b>description</b>				<b>code</b>	<b>note</b>		<b>Manual</b>						<b>code</b>	<b>note</b>				
N°1 Ethernet Port, Modbus® TCP and n°3 Modbus® RTU				1			None						0					
N°1 Profibus-DP® Port (with external communication module)				4			Italian						1					
N°1 Ethernet Port ProfiNet®				5			English						2					
							German						3					
							French						4					
<b>Aux Voltage to be coupled with an external transformer</b>				<b>11</b>												<b>16</b>		
<b>description</b>				<b>code</b>	<b>note</b>		<b>Version</b>						<b>code</b>	<b>note</b>				
24Vdc				4			Version 2						2					



# RPC412 / RPC424 - up to 24 1PH channel balanced on the three phases

## Connection Phase to Neutral

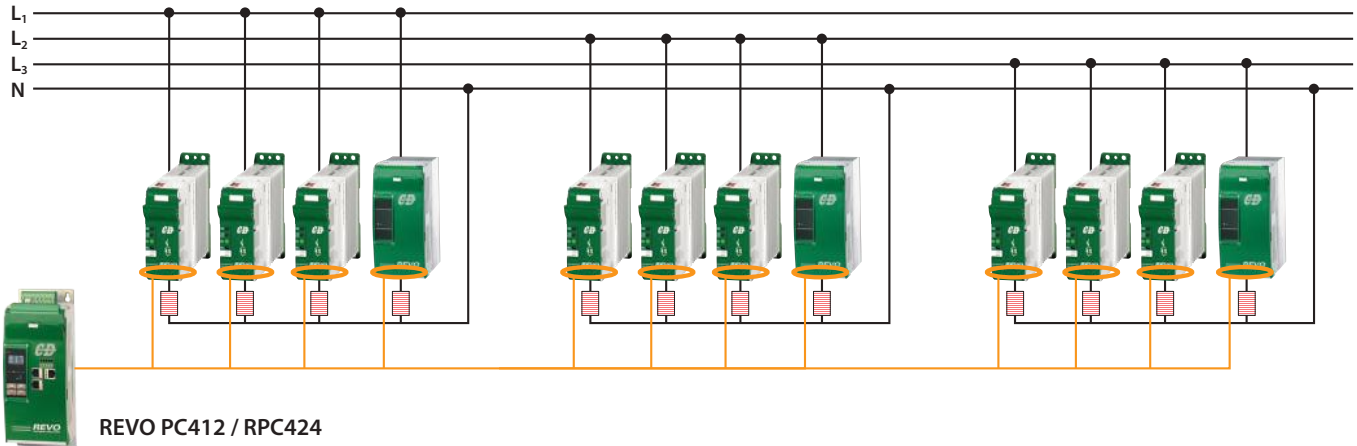

### Example:

N° 1	RPC412-0001411122		REVO PC 412
N° 3	RS1040-40SZOY0021	} L <sub>1</sub> -N	REVO S 1PH 40A, max main voltage 480V, No AUX voltage required, Logic input SSR, Fuse & Fuse Holder + integratedCT
N° 1	RS1090-40SZOY2021		REVO S 1PH 90A, max main voltage 480V, No AUX voltage without Logic input SSR, Integrated Fuses & CT, Fan 230V std
N° 3	RS1040-40SZOY0021	} L <sub>2</sub> -N	REVO S 1PH 40A, max main voltage 480V, No AUX voltage required, Logic input SSR, Fuse & Fuse Holder + integratedCT
N° 1	RS1090-40SZOY2021		REVO S 1PH 90A, max main voltage 480V, No AUX voltage without Logic input SSR, Integrated Fuses & CT, Fan 230V std
N° 3	RS1040-40SZOY0021	} L <sub>3</sub> -N	REVO S 1PH 40A, max main voltage 480V, No AUX voltage required, Logic input SSR, Fuse & Fuse Holder + integratedCT
N° 1	RS1090-40SZOY2021		REVO S 1PH 90A, max main voltage 480V, No AUX voltage without Logic input SSR, Integrated Fuses & CT, Fan 230V std

	1	2	3	4	5	6	7	8	9	10	11	12	13	14	15	16	
<b>ORDER CODE</b>	R	P	C	-	-	-	-	-	-	-	-	-	-	-	-	-	
<b>CONNECTION</b>				<b>4</b>									<b>12</b>				
<b>description</b>				<b>code</b>	<b>note</b>								<b>code</b>	<b>note</b>			
F1-N; F2-N; F3-N All the 1PH channel can be balanced on the three phases - Phase to Neutral				4									1	Half Cycle at 50% power demand			
													2	One Cycle at 50% power demand			
<b>CHANNELS</b>				<b>5</b>	<b>6</b>									<b>13</b>			
<b>description</b>				<b>code</b>	<b>note</b>								<b>code</b>	<b>note</b>			
12 channel REVO PC to drive 12 REVOS-1PH Max with Random Firing				1	2								1	No Feed Back			
24 channel REVO PC to drive 24 REVOS-1PH Max with Random Firing				2	4								2	Power			
<b>One Current Sensor Input for each channel</b>				<b>7</b>	<b>8</b>	<b>9</b>									<b>14</b>		
<b>description</b>				<b>code</b>	<b>note</b>								<b>code</b>	<b>note</b>			
Current Sensor is included and integrated with REVO S 1PH units with "Y" Option				0	0								1	CE EMC			
													L	CE + cUL (pending)			
<b>Communication</b>						<b>10</b>									<b>15</b>		
<b>description</b>				<b>code</b>	<b>note</b>								<b>code</b>	<b>note</b>			
N°1 Ethernet Port, Modbus® TCP and n°3 Modbus® RTU				1									0	None			
N°1 Profibus-DP® Port (with external communication module)				4									1	Italian			
N°1 Ethernet Port ProfiNet®				5									2	English			
													3	German			
													4	French			
<b>Aux Voltage to be coupled with an external transformer</b>						<b>11</b>									<b>16</b>		
<b>description</b>				<b>code</b>	<b>note</b>								<b>code</b>	<b>note</b>			
24Vdc				4									2	Version 2			
<b>Version</b>														<b>code</b>	<b>note</b>		
<b>description</b>																	

# RPC 2 - Star without Neutral or Close Delta Connection

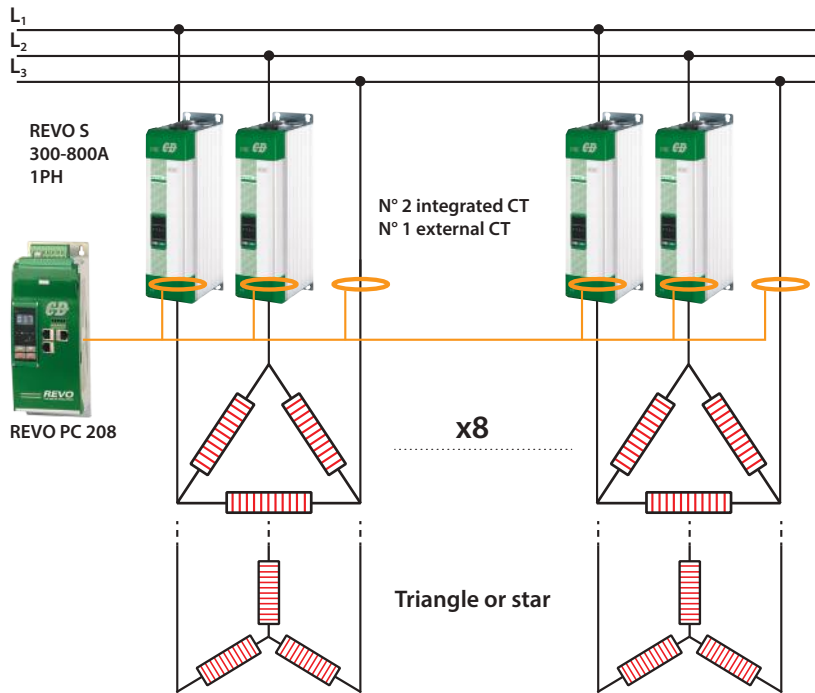

Up to n° 8 Three Phase Loads for each REVO PC 208

## Example:

N° 1	RPC208-0001421122	REVO PC 208
N° 16	RS1600-77SZOY2021	REVO S 1PH 600A, max main voltage 690V, AUX voltage supply range: 540 to 759Vac, Logic input SSR, Fixed Fuse + CT, Fan 230V std
N° 8	TA006	TA 800/0,5

ORDER CODE	1	2	3	4	5	6	7	8	9	10	11	12	13	14	15	16
	R	P	C	-	-	-	-	-	-	-	-	-	-	-	-	-

CHANNELS	4	5	6
<b>description</b>	<b>code</b>	<b>code</b>	<b>note</b>
REVO-PC to drive N°4 of 3 Phase Loads with two legs (2PH) N°8 SSR output to drive N°8 REVO S 1PH	2	0	4
REVO-PC to drive N°8 of 3 Phase Loads with two legs (2PH) N°16 SSR output to drive N°16 REVO S 1PH	2	0	8

Current Sensor Input	7	8	9
<b>description</b>	<b>code</b>	<b>code</b>	<b>note</b>
N°3 Current Sensor Input for each three phase channel are required.			
Current Sensor is included and integrated with REVO S 1PH units with "Y" Option.			
For 2PH control N°2 REVO S 1PH units with "Y" option are required + an additional Current Transformer	0	0	0
For 3PH control N°3 REVO S 1PH units with "Y" option are required			

Communication	10
<b>description</b>	<b>code</b>
N°1 Ethernet Port, Modbus® TCP and n°3 Modbus® RTU	1
N°1 Profibus-DP® Port (with external communication module)	4
N°1 Ethernet Port ProfiNet®	5

Aux Voltage to be coupled with an external transformer	11
<b>description</b>	<b>code</b>
24Vdc	4

Firing	12
<b>description</b>	<b>code</b>
One Cycle at 50% power demand	2

FEED BACK (Control Mode)	13
<b>description</b>	<b>code</b>
No Feed Back	1
Power	2

Approvals	14
<b>description</b>	<b>code</b>
CE EMC	1
CE + cUL (pending)	L

Manual	15
<b>description</b>	<b>code</b>
None	0
Italian	1
English	2
German	3
French	4

Version	16
<b>description</b>	<b>code</b>
Version 2	2

External Current Sensor			
description	code	description	code
50/0,05	000	400/0,5	005
100/0,5	001	800/0,5	006
150/0,5	002	1000/0,5	007
200/0,5	003	1500/0,5	008
250/0,5	004	2000/0,5	009

# RPC 3 - Star + Neutral Connection

Up to n° 8 Three Phase Loads for each REVO PC 308

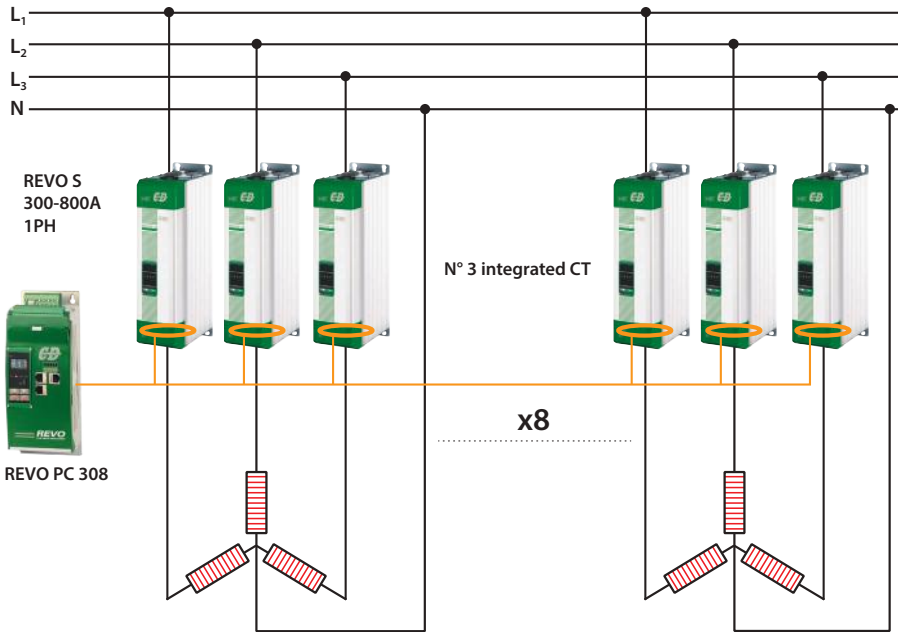

## Example:

N° 1 RPC308--0001411122 REVO PC 612

N° 24 RS1800-45SZOY2021 REVO S 1PH 800A, max main voltage 480V, AUX voltage supply range: 342 to 528Vac, Logic input SSR, Fixed Fuse + CT, Fan 230V std

ORDER CODE	1	2	3	4	5	6	7	8	9	10	11	12	13	14	15	16
	R	P	C	-	-	-	-	-	-	-	-	-	-	-	-	-

CHANNELS	4	5	6	
<b>description</b>	<b>code</b>			<b>note</b>
REVO-PC to drive N°4 of 3 Phase Loads with three legs (3PH) N°12 SSR output to drive N°12 REVO S 1PH	3	0	4	
REVO-PC to drive N°8 of 3 Phase Loads with three legs (3PH) N°24 SSR output to drive N°24 REVO S 1PH	3	0	8	

FEED BACK (Control Mode)	13	
<b>description</b>	<b>code</b>	<b>note</b>
No Feed Back	1	
Power	2	

Current Sensor Input	7	8	9	
<b>description</b>	<b>code</b>			<b>note</b>
N°3 Current Sensor Input for each three phase channel are required.				
Current Sensor is included and integrated with REVO S 1PH units with "Y" Option.	0	0	0	

Approvals	14	
<b>description</b>	<b>code</b>	<b>note</b>
CE EMC	1	
CE + cUL (pending)	L	

Communication	10	
<b>description</b>	<b>code</b>	<b>note</b>
N°1 Ethernet Port, Modbus® TCP and n°3 Modbus® RTU	1	
N°1 Profibus-DP® Port (with external communication module)	4	
N°1 Ethernet Port ProfiNet®	5	

Manual	15	
<b>description</b>	<b>code</b>	<b>note</b>
None	0	
Italian	1	
English	2	
German	3	
French	4	

Aux Voltage to be coupled with an external transformer	11	
<b>description</b>	<b>code</b>	<b>note</b>
24Vdc	4	

Version	16	
<b>description</b>	<b>code</b>	<b>note</b>
Version 2	2	

Firing	12	
<b>description</b>	<b>code</b>	<b>note</b>
Half Cycle (only with Neutral)	1	
One Cycle at 50% power demand	2	

# REVO S SELECTION FOR REVO PC

## REVO S 1PH SIZE AND DIMENSION



**SR6** H 121 x W 36 x D 185 - 0,61KG.



**SR12** H 269 x W 93 x D 170 - 3,4KG.  
**SR15** H 273 x W 93 x D 170 - 3,6KG.

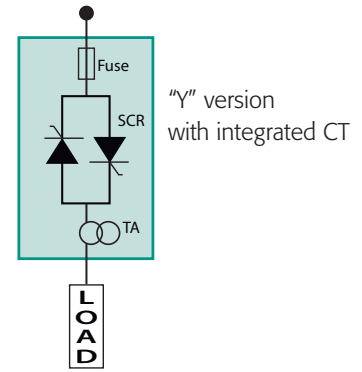

**S11** H 440 x W 137x D 270 - 10,5KG.



**S12** H 520 x W 137 x D 270 - 15KG.



**S15** H 560 x W 137x D 270 - 10,5KG.

### Technical Specification: REVO S 1PH to be coupled with REVO PC

- **Load type:** Normal resistance, infrared short and medium waveform
- **Inputs:** SSR Standard
- **Firing mode:** Zero Crossing
- **Operating temperature:** 0 to 40°C without derating
- **Comply with EMC** and cUL® up to 800A as an option
- **100 KA:** Short Circuit Current rating (SCCR) up to 600V
- **Data sheet:** More details on "REVO S 1PH" Manual

	1	2	3	4	5	6	7	8	9	10	11	12	13	14	15	16	
<b>ORDER CODE</b>	R	S	I	-	-	-	-	-	-	-	-	-	-	-	-	-	
<b>CURRENT</b>	<b>4</b>	<b>5</b>	<b>6</b>							<b>10</b>							
<b>description</b>	<b>code</b>	<b>code</b>	<b>code</b>	<b>Size 480-600V</b>	<b>Size 690V</b>	<b>note</b>	<b>FIRING</b>	<b>description</b>	<b>code</b>	<b>code</b>	<b>description</b>	<b>note</b>					
30A	0	3	0	SR3-SR6	Not available		Zero Crossing	Z			To get single cycle	2					
35A	0	3	5	SR3-SR6	Not available		<b>CONTROL MODE</b>	<b>11</b>									
40A	0	4	0	SR3-SR6	Not available		<b>description</b>	<b>code</b>	<b>code</b>	<b>description</b>	<b>note</b>						
60A	0	6	0	SR12	S11		Open Loop	0									
90A	0	9	0	SR15	S11		<b>FUSES &amp; OPTION</b>	<b>12</b>									
120A	1	2	0	SR15	S11		<b>description</b>	<b>code</b>	<b>code</b>	<b>description</b>	<b>note</b>						
150A	1	5	0	SR15	S11		≤ 40A			Fuse + Fuse Holder + CT	Y						
180A	1	8	0	SR15	S11		> 40A			Fixed Fuses Std + CT	Y						
210A	2	1	0	SR15	S11		<b>FAN VOLTAGE</b>	<b>13</b>									
300A	3	0	0	S12	not available		<b>description</b>	<b>code</b>	<b>code</b>	<b>description</b>	<b>note</b>						
400A	4	0	0	S12	S12		No Fan < 90A	0		Fan 115V ≥ 90A	1						
500A	5	0	0	S12	S12		Fan 230V ≥ 90A Std Version	2		Fan 24Vdc ≥ 90A	3						
600A	6	0	0	S12	S12		<b>APPROVALS</b>	<b>14</b>									
700A	7	0	0	S12	S12		<b>description</b>	<b>code</b>	<b>code</b>	<b>description</b>	<b>note</b>						
800A	8	0	0	S15	S15	5	CE EMC For European Market	0		CE EMC + cUL® listed and cULus 508® listed	L		5				
<b>MAX VOLTAGE</b>	<b>7</b>																
<b>description</b>	<b>code</b>																
480V	4																
600V	6																
690V	7																
<b>VOLTAGE SUPPLY AUX</b>	<b>8</b>																
<b>description</b>	<b>code</b>																
≤ 210A																	
No Aux.	0																
> 210A																	
90:130V	1																
170:265V	2																
230:345V	3																
300:530V	5																
510:690V	6																
600:760V	7																
<b>INPUT</b>	<b>9</b>																
<b>description</b>	<b>code</b>																
SSR	S																
<b>MANUAL</b>	<b>15</b>																
<b>description</b>	<b>code</b>																
None	0																
Italian	1																
English	2																
German	3																
French	4																
<b>VERSION</b>	<b>16</b>																
<b>description</b>	<b>code</b>																
Std unit	1																

**Note (1)** Load voltage must be included in Selected Auxiliary Voltage Range for units >210A  
**Note (2)** With 690V the firing is random  
**Note (3)** Available on unit ≥60A **Note (4)** 690V unit are available with CE only **Note (5)** CE standard + cUL® as an option, UL® for 800A

# REVO SX MULTICHANNEL 1PH UNITS

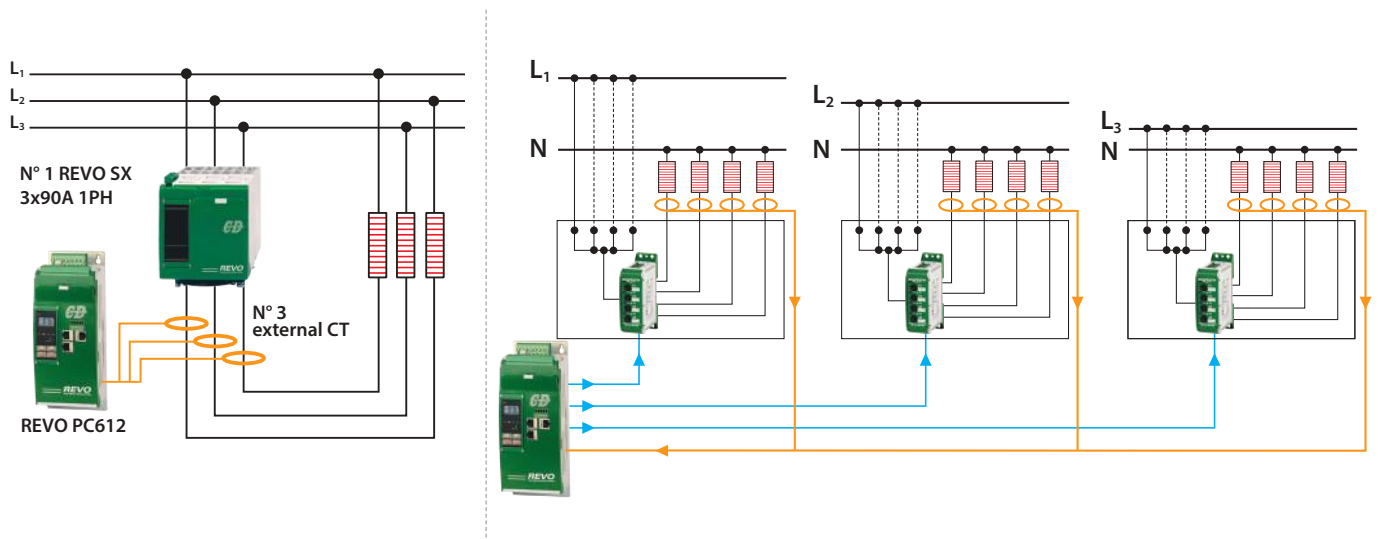

## Example:

N° 1	RPC612-0001421122	REVO PC 308
N° 1	RSX390-...	REVO SX 3 zones 90A each ...



SR25 H 180 x W 116 x D 183 - 2,35 kg

	1	2	3	4	5	6	7	8	9	10	11	12	13	14	15	16
<b>ORDER CODE</b>	R	S	X	-	-	-	-	-	-	-	-	-	-	-	-	-
<b>NUMBER OF ZONES X CURRENT RATING</b>	4 5 6															
description	code			note												
2 zones 50A each	2	5	0													
2 zones 60A each	2	6	0													
2 zones 75A each	2	7	5													
2 zones 90A each	2	9	0													
3 zones 50A each	3	5	0													
3 zones 60A each	3	6	0													
3 zones 75A each	3	7	5													
3 zones 90A each	3	9	0													
<b>MAX VOLTAGE</b>	7															
description	code			note												
480V	4															
600V	6															
<b>VOLTAGE SUPPLY AUX</b>	8															
description	code			note												
No Auxiliary Voltage	0															
<b>INPUT</b>	9															
description	code			note												
SSR	S															
<b>FIRING</b>	10															
description	code			note												
Zero Crossing	Z															
<b>CONTROL MODE</b>												11				
description												code		note		
Open Loop												0				
<b>FUSES &amp; OPTION</b>												12				
description												code		note		
Integrated fuses												F				
<b>FAN VOLTAGE</b>												13				
description												code		note		
No Fan Voltage (only RSX250)												0				
Standard: 24Vdc Fan (All unit with exception of RSX250)												3				
<b>APPROVALS</b>												14				
description												code		note		
CE EMC For European Market												0				
<b>MANUAL</b>												15				
description												code		note		
None												0				
Italian												1				
English												2				
German												3				
French												4				
<b>VERSION</b>												16				
description												code		note		
Version 1												1				

# INFRARED OVEN AND THERMOFORMING

## INFRARED LAMPS WITH MEDIUM AND SHORT WAVE FORM

REVO PC is the best solution to control all types of infrared lamps.

The robust junction with high I<sup>2</sup>T allows it to drive short-wave IR lamps.

There are several types of soft start, which reduce much of the flickering phenomenon.

The synchronization makes the power factor close to one.

Power Network voltage fluctuations are compensated instantly via the feedback in the unit.

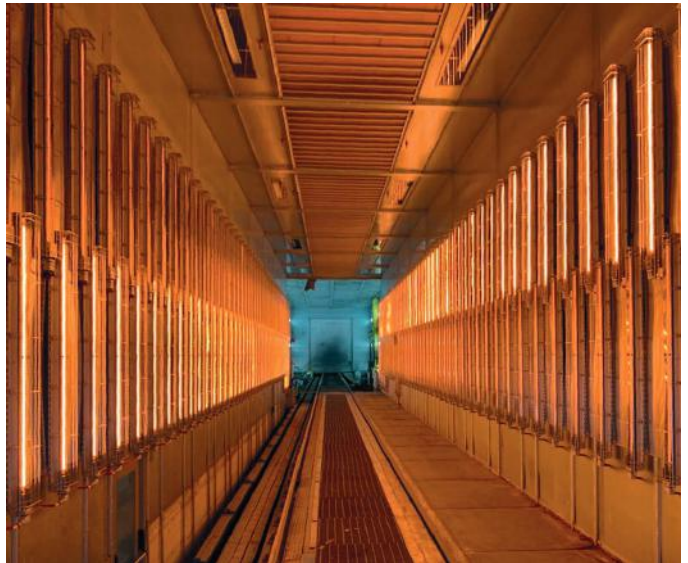

# PLASTIC EXTRUSION MACHINE

## AUTOMATION SOLUTION FOR EXTRUSION LINES

- Scalable power management, single extruder or full line.
- Cyclic reading and writing of process variables.
- Short circuit SCR and load brake diagnostics.
- Reduced power consumption due to power grid fluctuations through live control.
- Maintains instantaneous power in the contractual limits with a power factor close to one.
- Strong bulk reduction and cabling for co-extrusion systems that can pass 100 zones.
- Distributed solutions with cable and labour cost reduction.

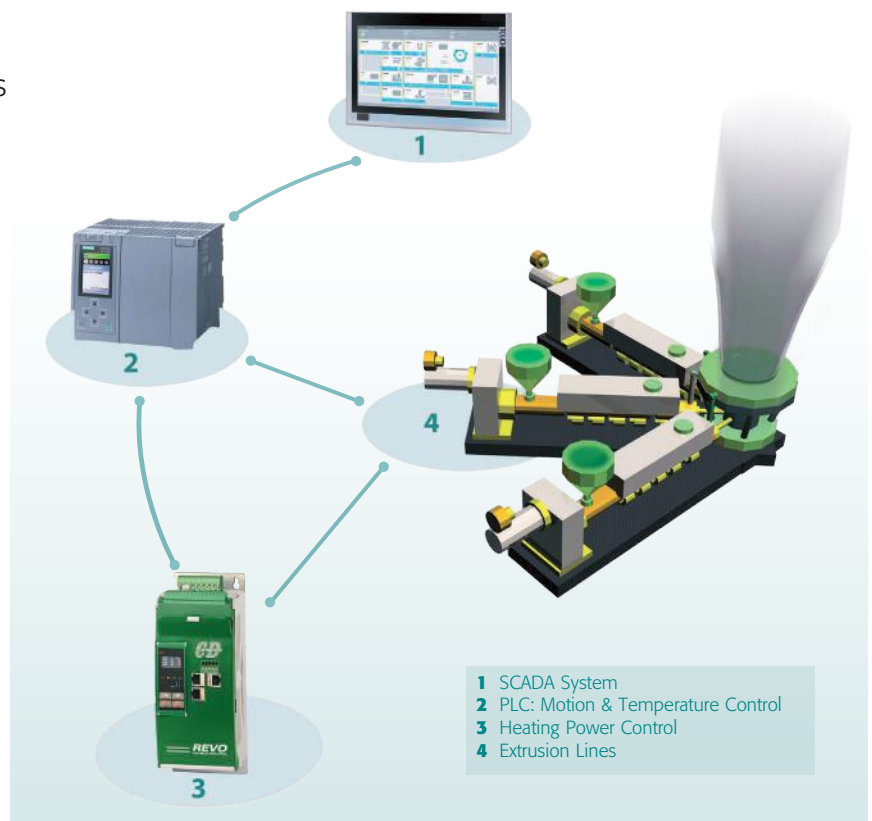





# SPECIAL LOADS

## MOSI<sub>2</sub> HEATING ELEMENTS (KANTHAL SUPER® ELEMENTS)

This kind of heaters increase resistivity sharply with temperature but do not change with age.

The initial current at cold elements can be 16 times the rated current.

For this type of application, it is necessary to use units that allow a phase angle firing with soft start (3 sec.) and current limit.

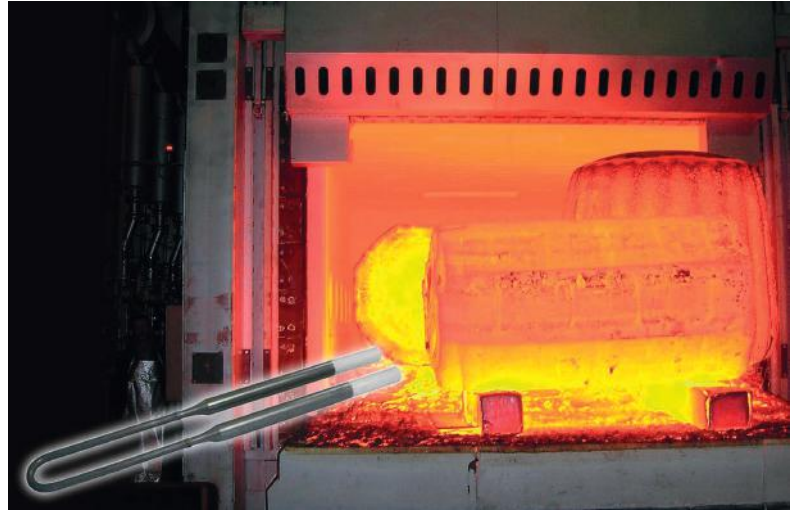

### PHASE TO PHASE CONNECTION REVO PC624 24 Channels Max

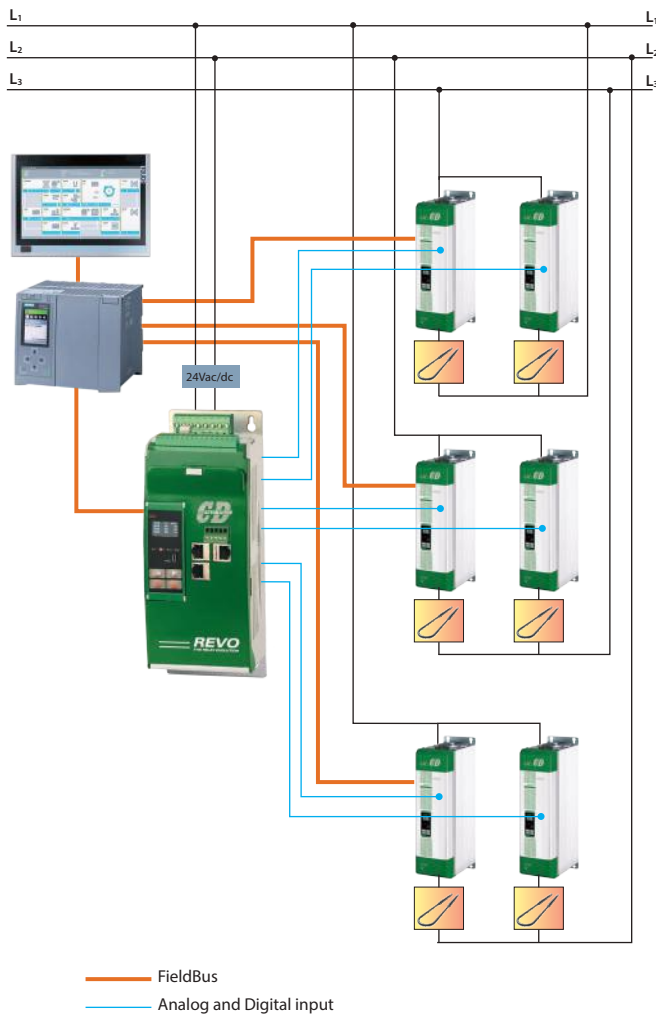

### PHASE TO NEUTRAL CONNECTION REVO PC424 24 Channels Max

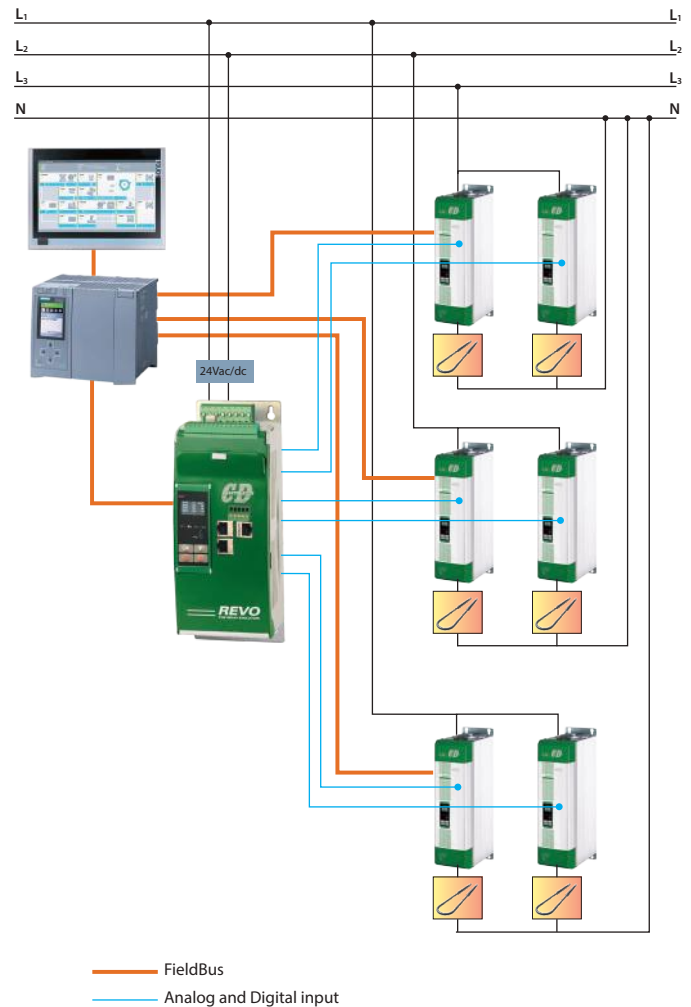



### **Italy**

CD Automation Srl  
Via Picasso, 34/36  
20025 Legnano MI  
Italy  
T +39 0331 577479  
F +39 0331 579479  
sales@cdautomation.com  
www.cdautomation.com

### **United Kingdom**

CD Automation UK Ltd  
Unit 9 Harvington Business Park  
Brampton Road, Eastbourne  
East Sussex, BN22 9BN  
England  
T +44 1323 811100  
info@cdautomation.co.uk  
www.cdautomation.co.uk

### **India**

M/s Toshcon CD Automation Pvt. Ltd.  
H1 - 75 Gegal Industrial Area  
Ajmer - 305023 (Raj.)  
India  
T +91 145 2791112  
T +91 145 6450601/2/3  
sales.cd@toshcon.com  
www.cdautomation.in